

**idéfleX**

**Katalog 2006**

## Die Grundelemente

Ausführungen: chrom, schwarz oder weiss.

Grössen: Breite x Tiefe x Höhe

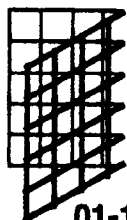

**01-1001A**  
Flex-Modul  
35x35x50 cm

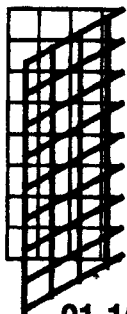

**01-1003A**  
Flex-Modul  
35x35x80 cm

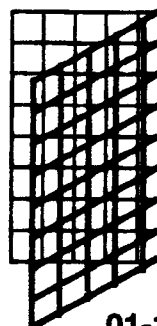

**01-1003**  
Flex-Modul  
45x45x80 cm

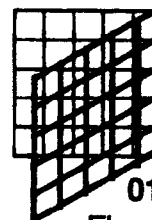

**01-1001**  
Flex-Modul  
45x45x50 cm

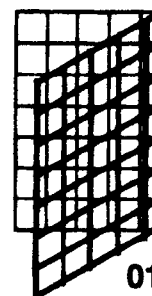

**01-1002**  
Flex-Modul  
45x45x70 cm

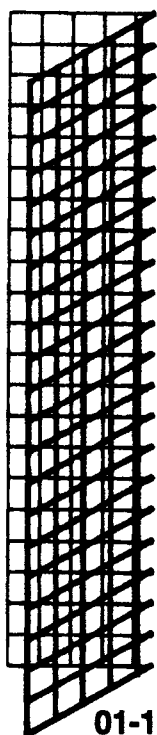

**01-1008**  
Flex-Modul  
45x45x210 cm

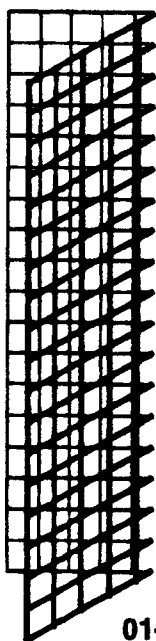

**01-1007**  
Flex-Modul  
45x45x180 cm

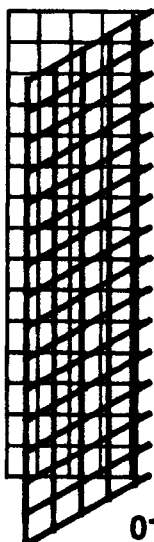

**01-1006**  
Flex-Modul  
45x45x150 cm

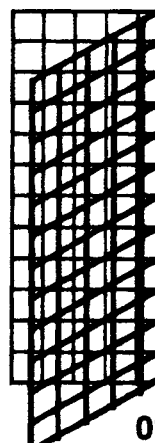

**01-1005**  
Flex-Modul  
45x45x120 cm

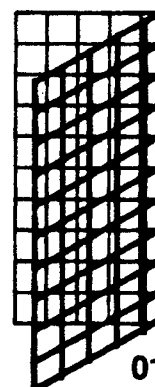

**01-1004**  
Flex-Modul  
45x45x100 cm

Flex-Module

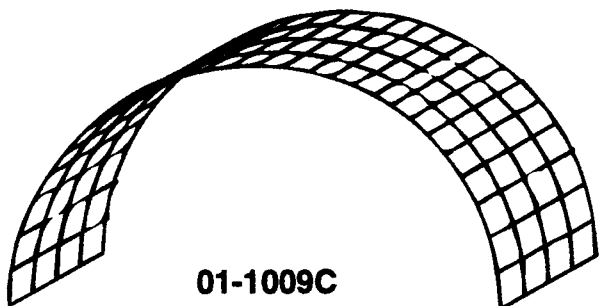

**01-1009C**  
Gitterbogen  
180x40x90 cm



**01-1009A**  
Gitterbogen  
45x40x22.5 cm

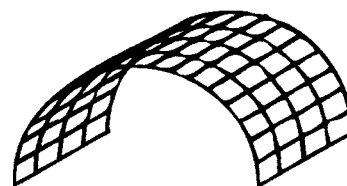

**01-1009B**  
Gitterbogen  
90x40x45 cm

Gitterbogen

Am Ende des Katalogs befindet sich eine aufklappbare Seite mit Aufstellbeispiel 

## Gitterwände

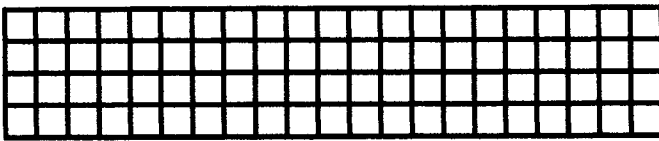

**01-1014A**  
Netz  
40x210 cm

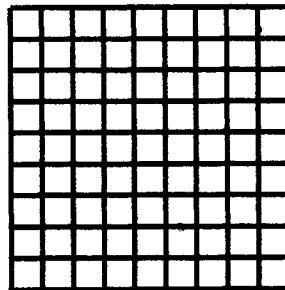

**01-1010**  
Netz  
90 x 90 cm

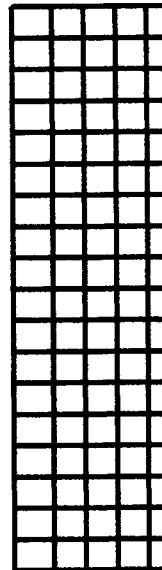

**01-1013AG**  
Abschlussgitter  
45x180 cm

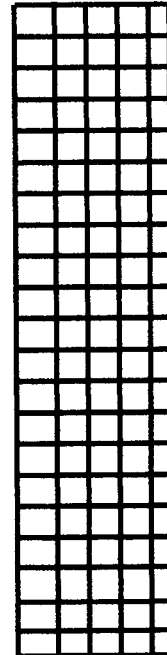

**01-1014AG**  
Abschlussgitter  
45x210 cm

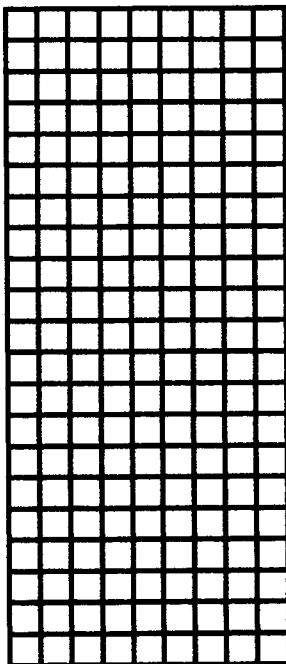

**01-1014**  
Netz  
90 x 210 cm

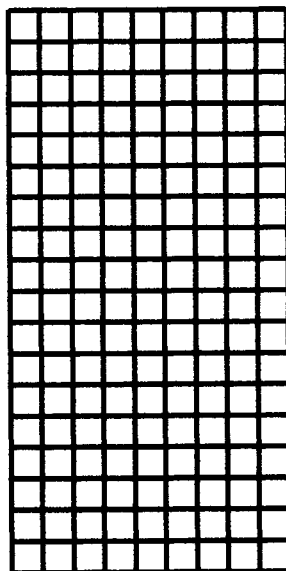

**01-1013**  
Netz  
90 x 180 cm

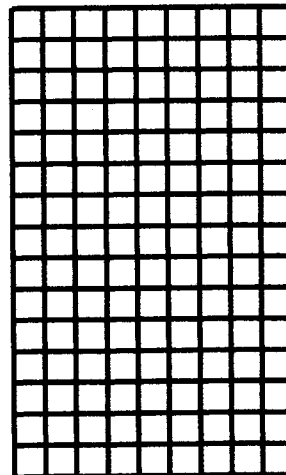

**01-1012**  
Netz  
90 x 150 cm

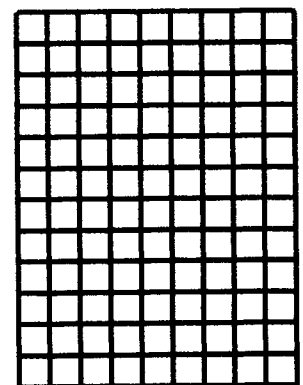

**01-1011**  
Netz  
90 x 120 cm

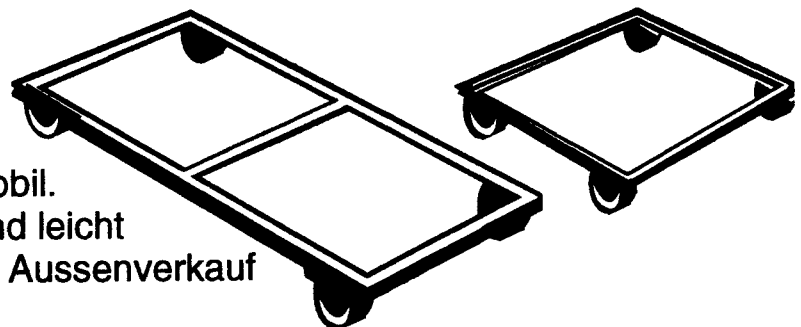

Mit Rollwagen wird idéflex mobil. Sonderstände sind schnell und leicht erstellt. Sie sind auch für den Aussenverkauf bestens geeignet. Es können auch mit mehreren Wagen Verkaufsinselformen gebildet werden.

# idéflex

## Die Montage

Aufstellen...

... und einfach zusammenschnappen.

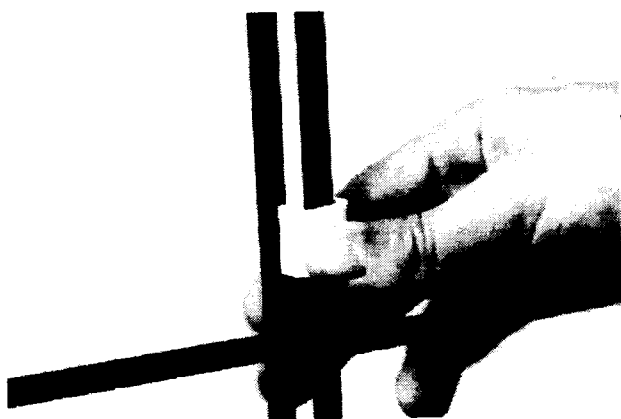

12-1200  
System-Clip

Zur besseren Fixierung mit...

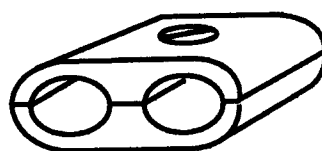

Elementverbinder  
(zum Schrauben)  
19-81026x

... oder mit Halter für die Wandmontage

Montagezubehör

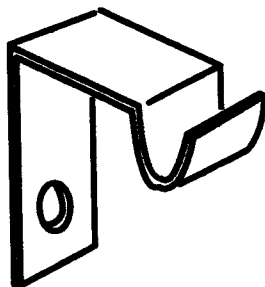

11-1023  
Beschlag für  
Wandmontage  
(Distanz zur  
Wand 3,5cm)

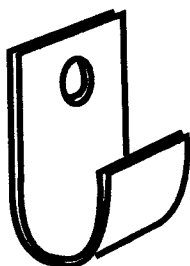

11-1025  
Kombibeslag für  
Wandmontage



11-1024  
Bügel zur direkten  
Wandmontage

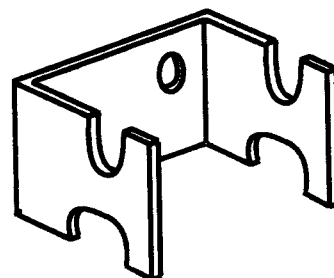

21G 2011  
Wandhalterung  
für Netz

oder mit Gitterstäben zwischen den Grundelementen...

Gitterstäbe

01-1018  
Gitterstab  
gerade  
100 cm



01-1020  
Gitterstab  
gerade  
25 cm

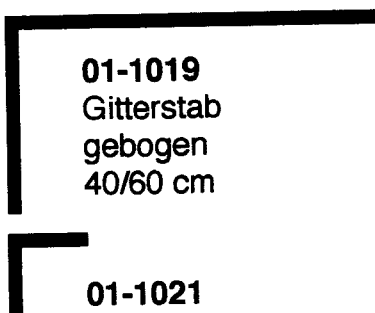

01-1019  
Gitterstab  
gebogen  
40/60 cm

01-1021  
Gitterstab  
gebogen  
12.5x12.5 cm

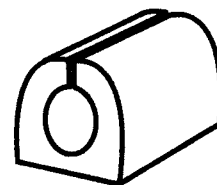

09-801 3220.58  
Gummifuss für  
Gitterelemente

## Die Tablare

weiss, schwarz, naturholz oder individuell

Holz

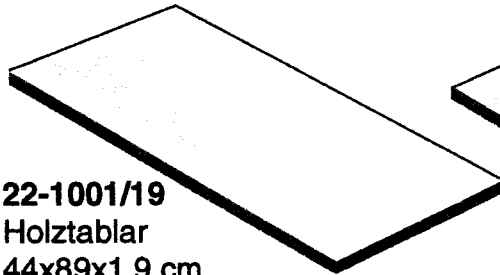

**22-1001/19**  
Holztablar  
44x89x1.9 cm

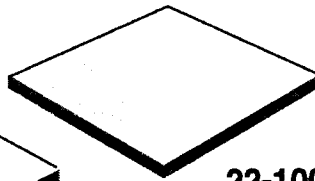

**22-1002/19**  
Holztablar  
44x44x1.9 cm



**22-1003/19**  
Holzlecktablar  
44x44/60x1.9 cm

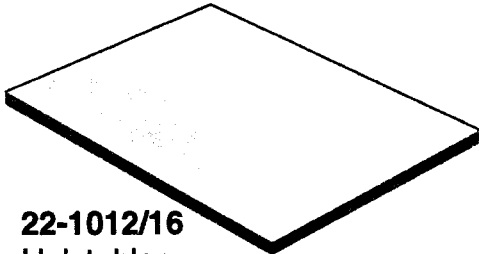

**22-1012/16**  
Holztablar  
(als eingebauter Tisch geeignet)  
60x89x1.6 cm

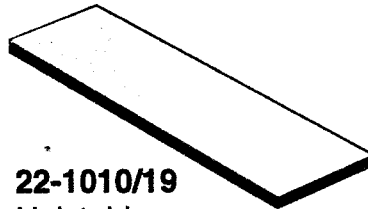

**22-1010/19**  
Holztablar  
30x89x1.6 cm

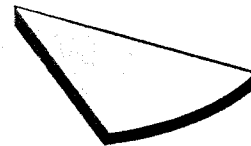

**22-1005/19**  
Holztablar 1/8 Kreis  
44x44 cm rund

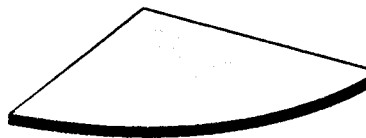

**22-1004/19**  
Holztablar  
1/4 Kreis  
44x44 cm rund

### ...oder aus Glas

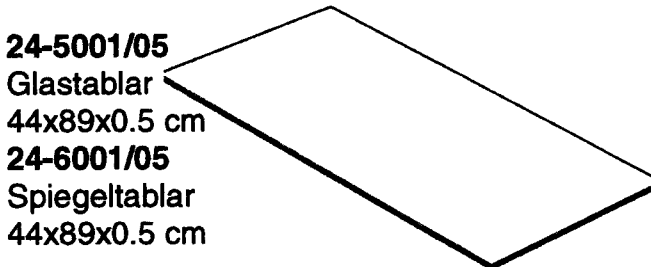

**24-5001/05**  
Glastablar  
44x89x0.5 cm  
**24-6001/05**  
Spiegeltablar  
44x89x0.5 cm

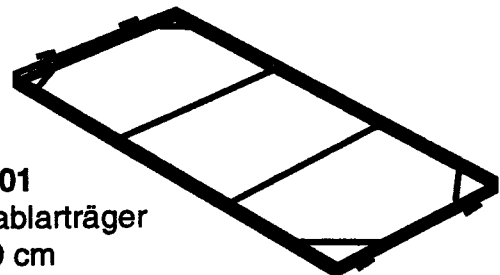

**11-3001**  
Glastablarträger  
44x89 cm

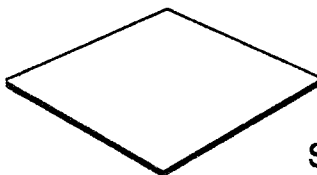

**24-5002/05**  
Glastablar  
**24-6002/05**  
Spiegeltablar  
44x44x0.5 cm

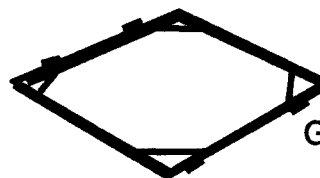

**11-3002**  
Glastablarträger  
44x44 cm

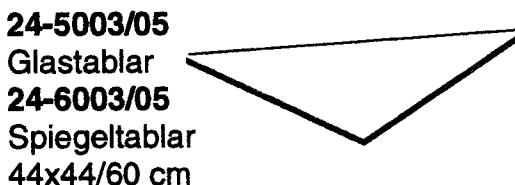

**24-5003/05**  
Glastablar  
**24-6003/05**  
Spiegeltablar  
44x44/60 cm

**11-3003**  
Glastablarträger  
44x44 cm

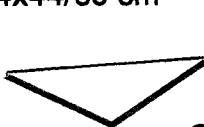

**24-5019/05**  
Glastablar  
**24-6019/05**  
Spiegeltablar  
24x24/35 cm



**11-3019**  
Glastablarträger  
24x24 cm

**24-5004/05**  
Glasecktablar  
**24-6004/05**  
Spiegelecktablar  
44x44 cm rund



**11-3004**  
Glastablarträger  
1/4 Kreis  
44x44 cm rund



Glas und Spiegel

# idéflex

Sie können die Holztablare: waagrecht, schräg...

Tablarträger

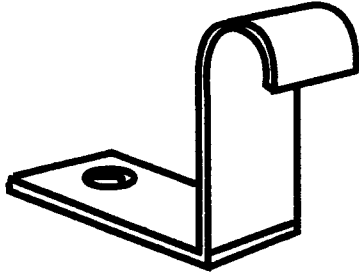

**11-1020**  
Tablarträger

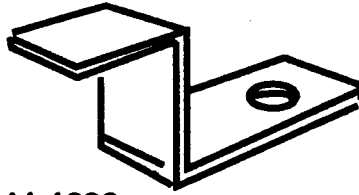

**11-1030**  
Kippsicherung für  
Ecktablare

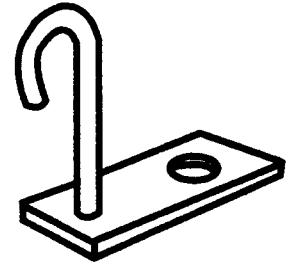

**11-1021**  
Träger für  
Schrägtablar

... oder direkt an die Grund-  
Elemente einhängen.

Schräge Tablare mit einer  
Acrylkante abschliessen ...

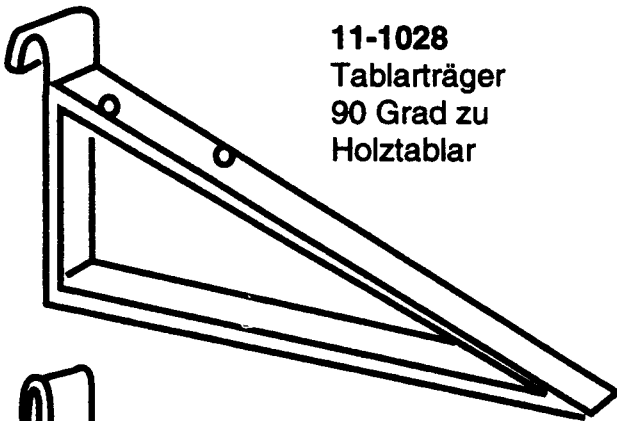

**11-1028**  
Tablarträger  
90 Grad zu  
Holztablar



**11-1029**  
Tablarträger  
45 Grad zu  
Holztablar

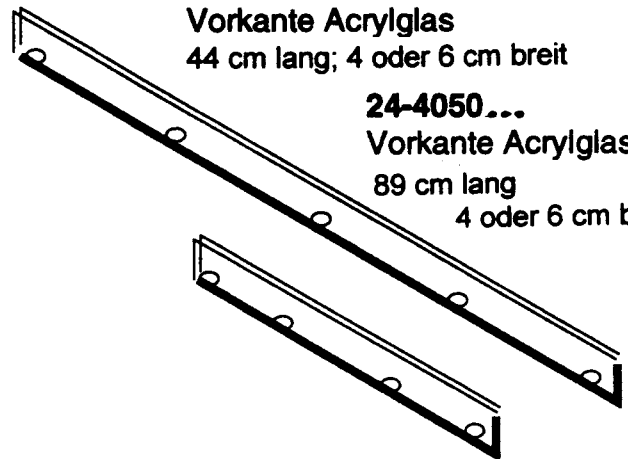

**24-4051 ...**  
Vorkante Acrylglas  
44 cm lang; 4 oder 6 cm breit

**24-4050 ...**  
Vorkante Acrylglas  
89 cm lang  
4 oder 6 cm breit

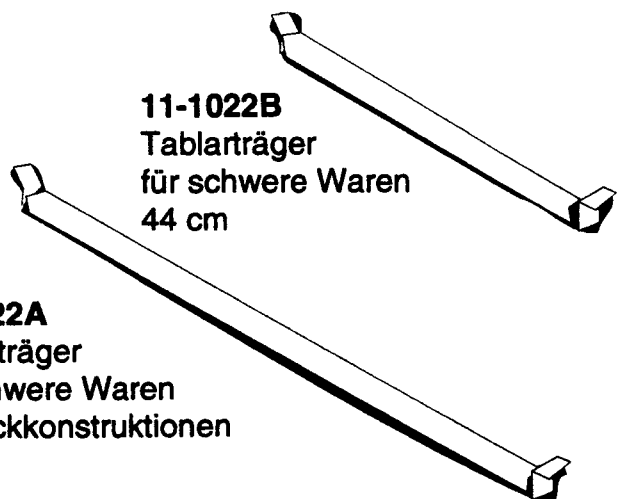

**11-1022B**  
Tablarträger  
für schwere Waren  
44 cm

**11-1022A**  
Tablarträger  
für schwere Waren  
und Eckkonstruktionen  
89 cm

... und die Tablare von unten verstärken.

## ... weitere Tablare

zum Einhängen: waagrecht oder schräg

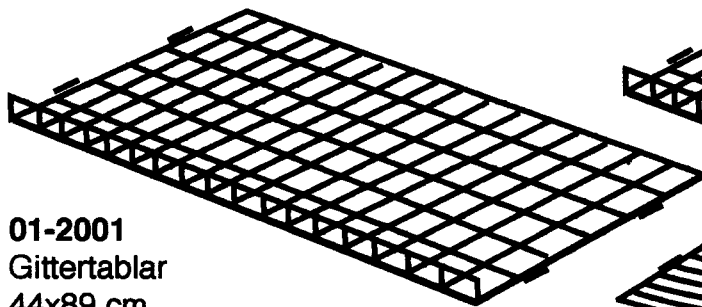

**01-2001**  
Gittertablar  
44x89 cm

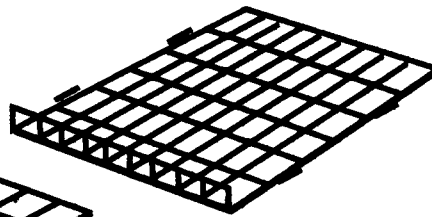

**01-2002**  
Gittertablar  
44x44 cm

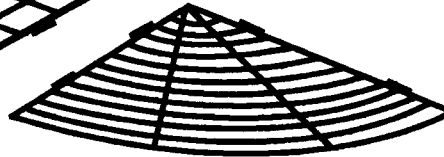

**01-2004**  
Gitterecktablar  
44x44 cm rund

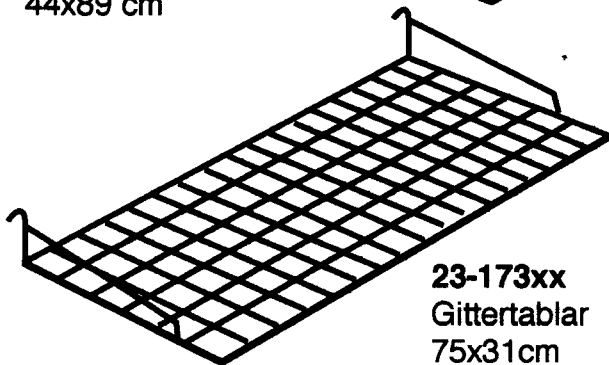

**23-173xx**  
Gittertablar  
75x31cm

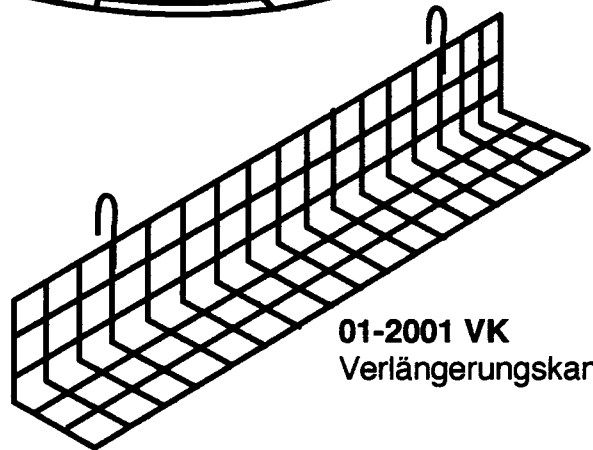

**01-2001 VK**  
Verlängerungskante

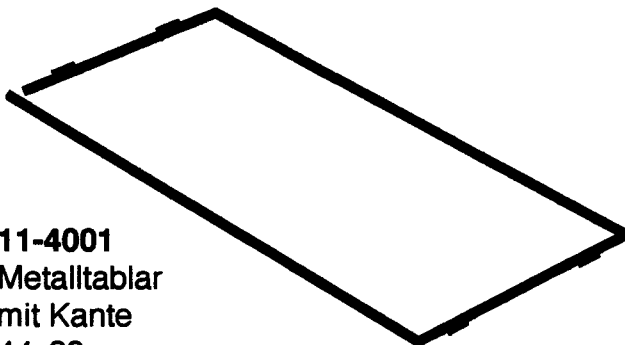

**11-4001**  
Metalltablar  
mit Kante  
44x89 cm

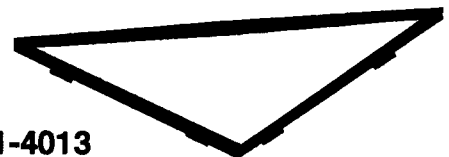

**11-4013**  
Metalltablar  
mit Kante  
44x44/60 cm  
11-4013

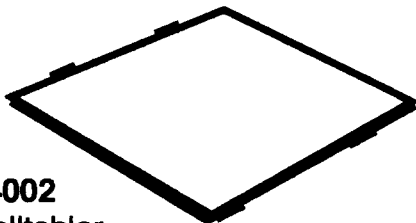

**11-4002**  
Metalltablar  
mit Kante  
44x44 cm

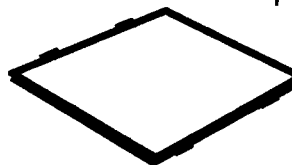

**11-4012**  
Metalltablar  
mit Kante  
34x34 cm  
11-4013



**11-4003**  
Metalltablar  
mit Kante  
44x44/60 cm

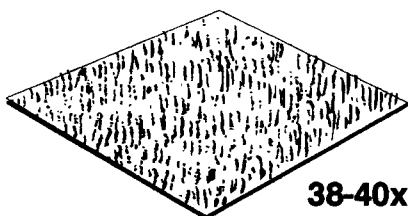

**38-40xx**

Rasenteppich zu Metalltablar



**11-4002**  
Metalltablar  
mit Kante  
44x44 cm

# idéflex

Zubehör



19-87000x  
Mini Klammer



19-87001x  
Maxi Klammer



19.592.101  
Einklammerbügel



16-2510040124  
Doppel S-Haken  
9 cm



11-1044  
S-Haken klein  
5 cm

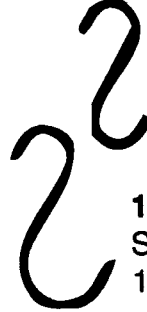

11-1045  
S-Haken gross  
10 cm

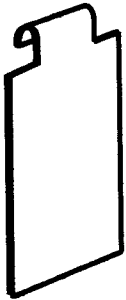

65-1001  
Nummernschild



01-1023  
Blumenhalter

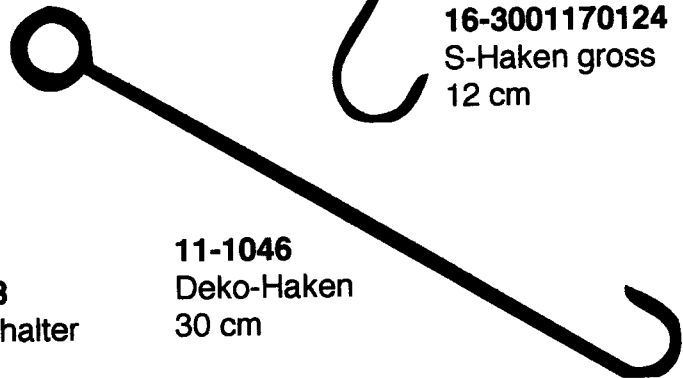

11-1046  
Deko-Haken  
30 cm

16-3001170124  
S-Haken gross  
12 cm

## Zubehör für Zeitschriften ...

23-174xx  
Zeitschriftenablage

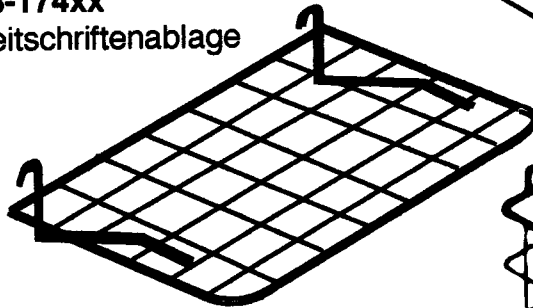

23-1744x  
Zeitschriftenständer

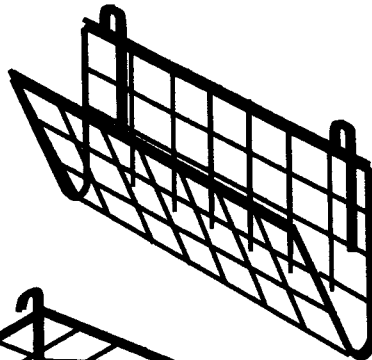

23-1738x  
Gitterkorb  
35x31 cm

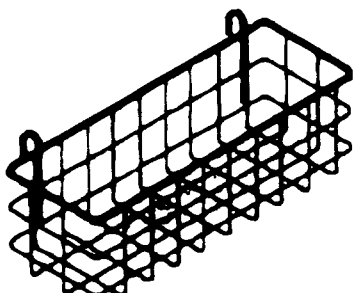
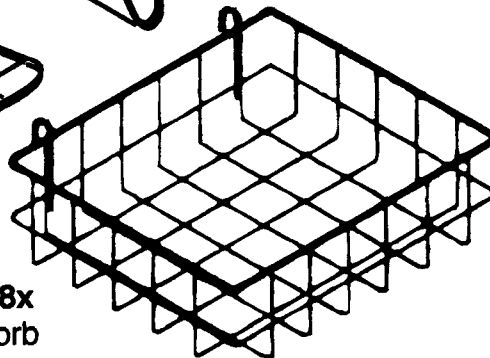

23-1740x  
Gitterkorb  
35x12 cm

## ... oder Postkarten

11-1150  
Kartenhalter  
6-teilig

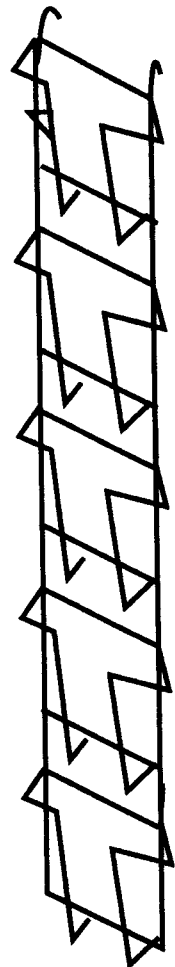

Körbe



## Das Zubehör

mehrheitlich in chrom, schwarz, weiss und acryl

**21F-4014**  
ausziehbare Kleiderstange  
86-150 cm

Haken  
**11-1050**  
35 cm

**11-1051**  
45 cm

**11-1052**  
55 cm

**11-1048**  
Hakenhalter

**11-1040** 10 cm  
**11-1041** 15 cm  
**11-1042** 20 cm  
**11-1043** 25 cm  
Haken

**11-1039**  
Deko Haken,  
stark, 20 cm

**11-1049**  
Deko Haken,  
stark, 5 cm

**11-1152**  
Doppel-Haken  
25 cm

**11-1151**  
Doppel-Haken  
15 cm

**21B-3001/44 KLS** 44 cm

**21B-3001/60 KLS** 60 cm

**21B-3001/90 KLS** 90 cm  
Kleiderstange mit Fixierung

**65-1003**  
Kleiderstangen-  
halterungen

**65-1002**  
Eckstange

**21B 3011**  
Wandbefestigung

**11-1047**  
Hakenarm für  
Kleider und  
Taschen

**11-1159**  
Doppelhaken-  
arm

**11-1053**  
Deko Haken mit Kugeln  
30cm

**21 F 411**  
Deko Haken mit  
Kugeln,schräg,stark,40 cm

**11-1054**  
Deko Haken mit  
Kugeln,schräg,30 cm

**16-2510030324**  
Doppel-Haken  
30 cm

## Das Mobiliar

Zum Einbau in die Grundelemente (mit Tablarträger 11-1022A) oder mit Bodensockel, Mobiliar in weiss

### Unterschranke

**22-9021**  
mit 2 Türen und  
Tablaren

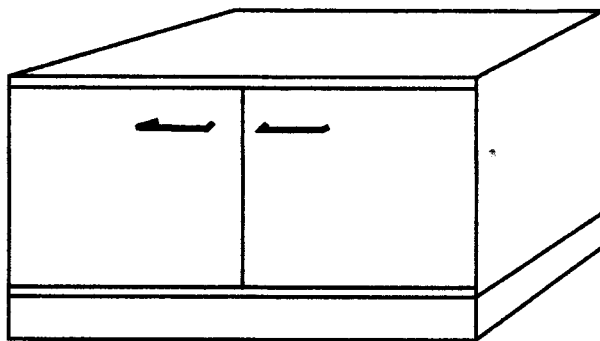

**22-9021S**  
mit 2 Türen und  
Tablaren, auf Sockel

**22-9022**  
mit 6 Schub-  
laden

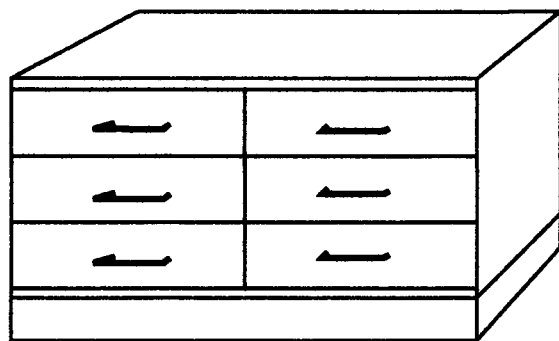

**22-9022S**  
mit 6 Schubladen,  
auf Sockel

### Für den attraktiven Bodenabschluss

### Sockel

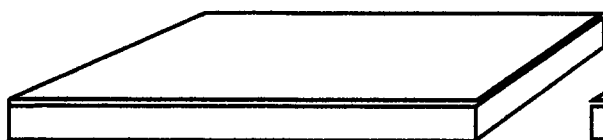

**22-9001**  
Sockel  
44x89 cm

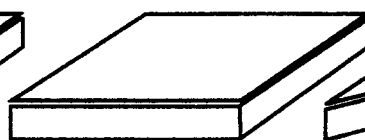

**22-9002**  
Sockel  
44x44 cm

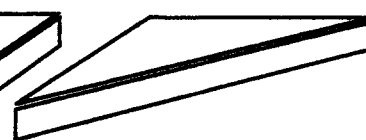

**22-9014**  
Sockel  
44x44/60 cm

### Tische

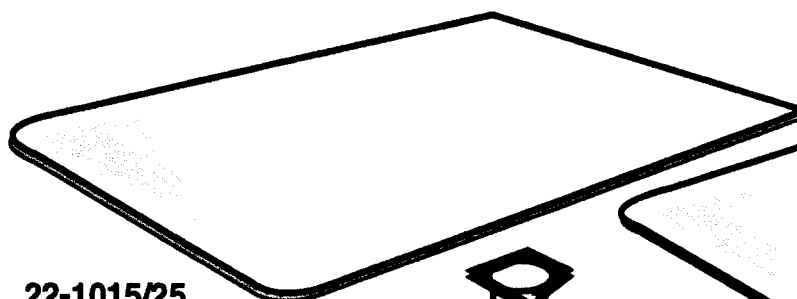

**22-1015/25**  
Tischplatte mit 2  
abgerundeten Ecken  
89x180x2,5 cm

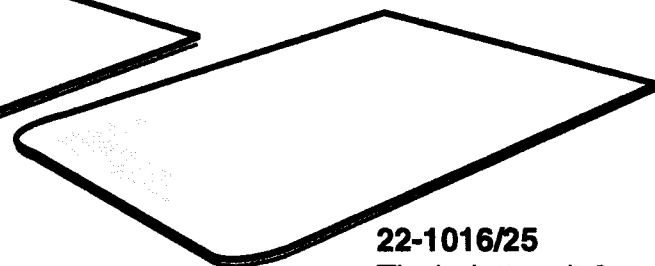

**22-1016/25**  
Tischplatte mit 2  
abgerundeten Ecken  
89x120x2,5 cm

**14-6720**  
Tischbein mit  
Stellschraube

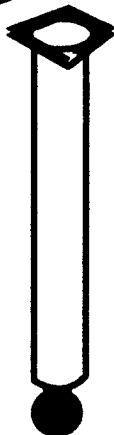

**11-1027**  
Tischträger  
zum Einhängen  
in Grundelemente

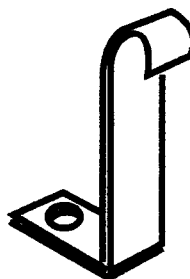

## Zubehör für Sportartikel...

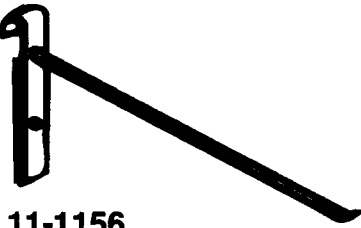

**11-1156**  
Spezialhaken für Ski  
mit Schraube



**11-1154**  
Spezialhaken für Ski

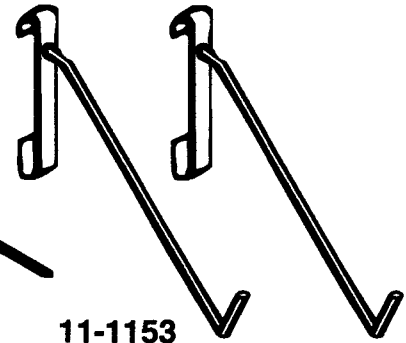

**11-1153**  
Spezialhaken für  
Snowboard

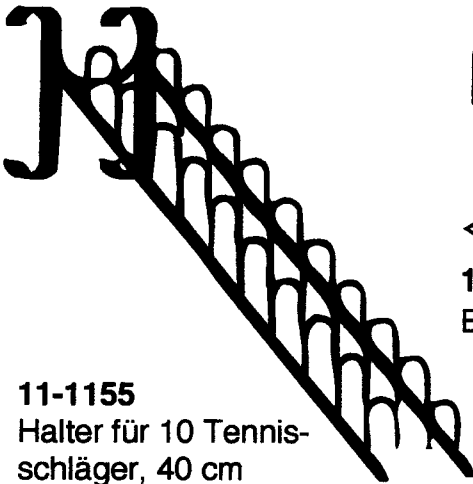

**11-1155**  
Halter für 10 Tennis-  
schläger, 40 cm

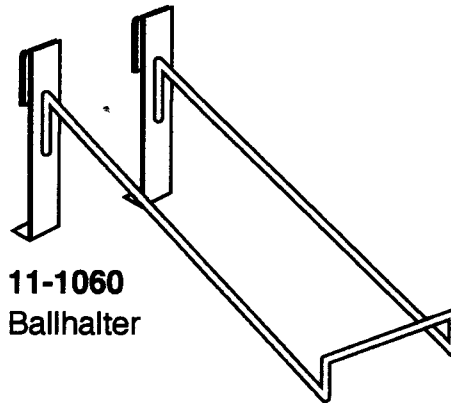

**11-1060**  
Ballhalter

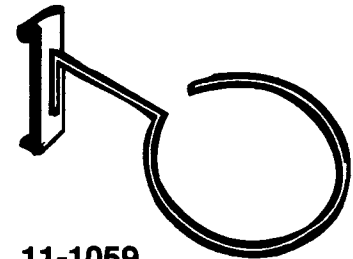

**11-1059**  
Fussball-Ring

## ... für Mützen und Hüte

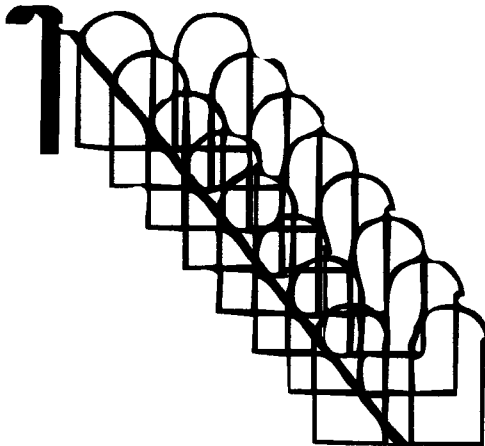

**09-07407.64**  
Halter für 16  
Wollmützen  
40cm

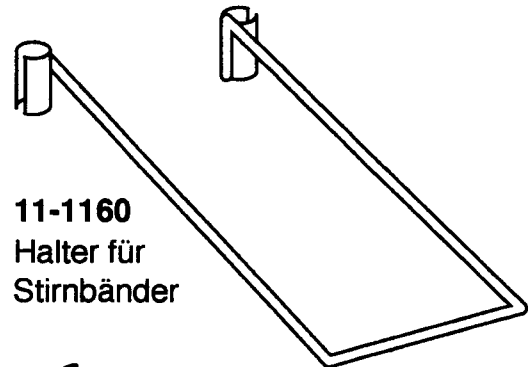

**11-1160**  
Halter für  
Stirnbänder

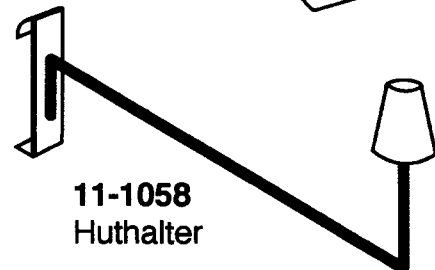

**11-1058**  
Huthalter

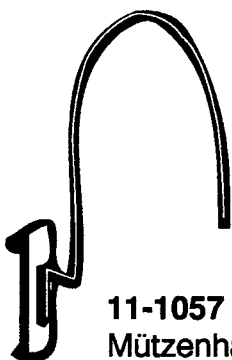

**11-1057**  
Mützenhalter

**01-1022**  
Halter:  
Baseballmützen  
Helme (Helme, Eishockey)  
Wollmützen

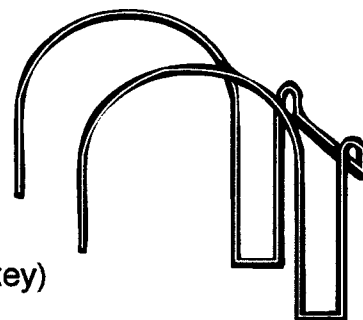

Spezialhalter für Sportartikel

Mützen

## Zubehör für Handschuhe und Schuhe...

Schuhzubehör



**09-07406.64**  
 Halter für 16  
 Handschuhe  
 40cm



**11-1157**  
 Halter für  
 Sportschuhe  
 35cm

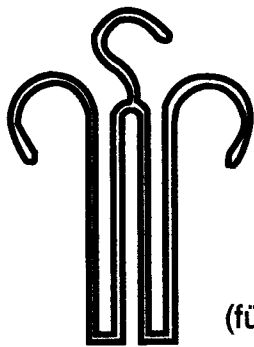

**19-870 102**  
 Schuhbügel  
 (für ein Paar Schuhe)



**11-1055**  
 Schuhstange  
 für idéflex

## Acryldisplay

Acryldisplay

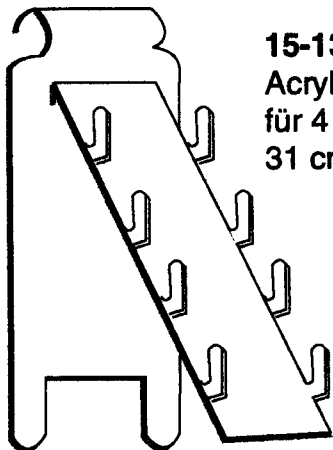

**15-131**  
 Acryldisplay  
 für 4 Brillen  
 31 cm

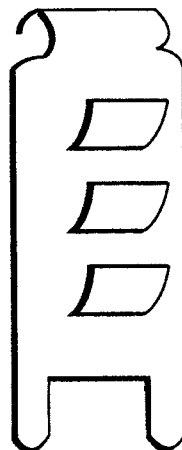

**15-130**  
 Acryldisplay  
 für 3 Brillen  
 22 cm

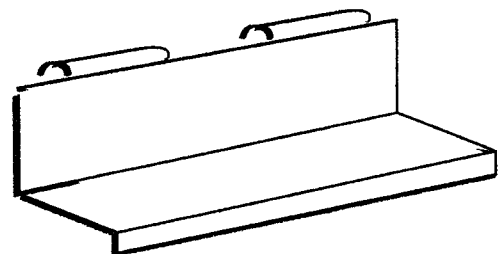

**15-100**  
 Schuhdisplay  
 aus Acryl  
 33 cm

... eine weitere Vielfalt an Zubehör auf Anfrage

## Werbetafeln

für Gitterbogen  
neutral weiss, bedruckbar  
Dicke: 2,5 mm



**17-8009 B**

Werbetafel für Gitterbogen:  
90x45 cm 01-1009B

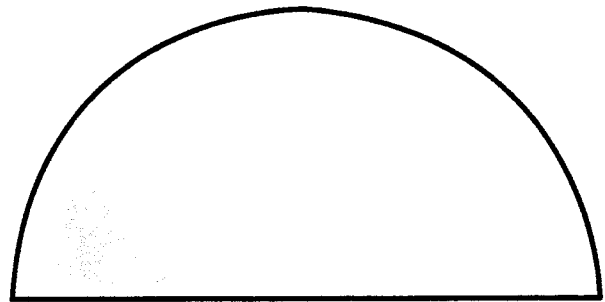

**17-8009 C**

Werbetafel für Gitterbogen:  
142x35 cm 01-1009C

## Leuchtkastenprogramm

Sie können Ihre Produkte mit Hilfe unseres Leuchtkastenprogramms brillant zur Geltung bringen. Sie brauchen lediglich Ihre individuelle Fotofolie einzulegen.

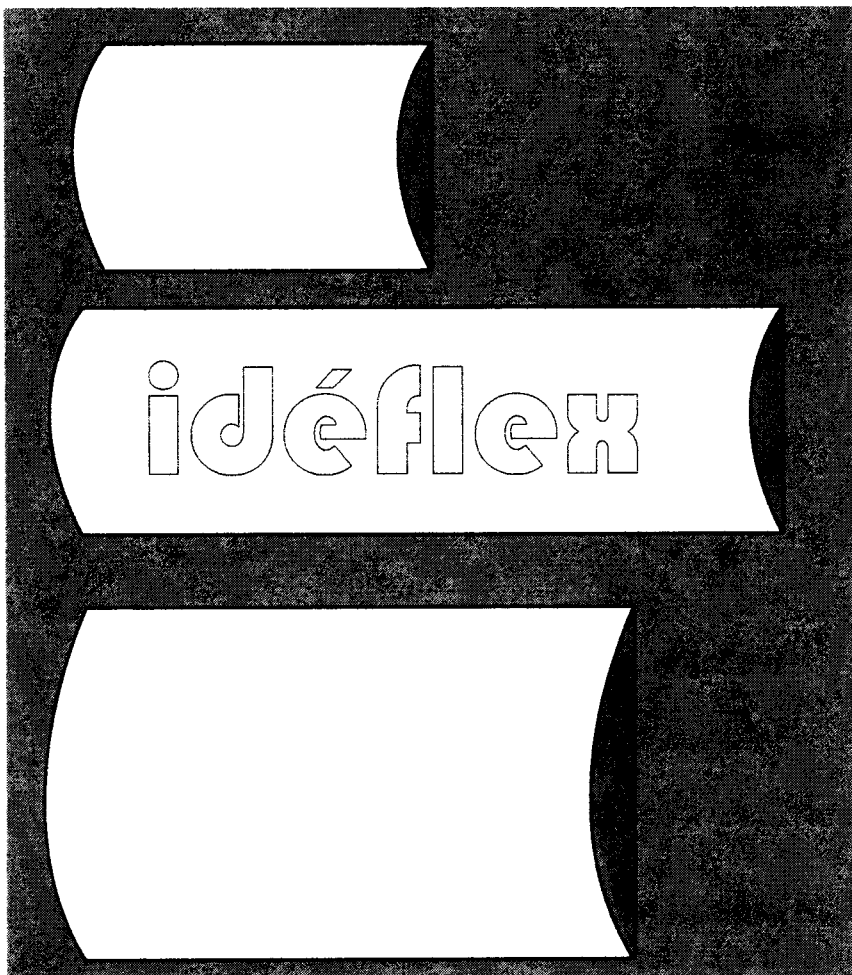

**3040**

Bildformat A3  
30x40x8 cm  
Lichtquelle: 11 W

**9030**

Bildformat: 4x A4 oder  
2x A3  
90x30x6  
Lichtquelle: FL 2 x 15 W

**7047**

Bildformat 70x50 cm  
70x47x8 cm  
Lichtquelle: FL 2 x 18 W

# idétube

farbige Frontrohre als dekorative Ergänzung zu den idéflex-Grundelementen.

in chrom oder lackiert (in allen RAL Farben)



95cm



115cm



145cm



175cm



205cm

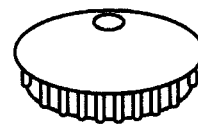

**21B 3017**  
Rohrabschluss

**21 B 3001**  
Frontrohr  
Ø 25 mm

## Rohre

## Bogen

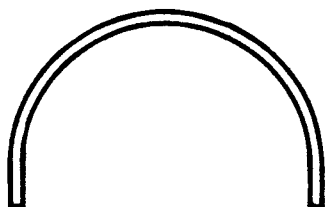

**21B 3001/B1**  
Rohr-Rundbogen  
90 cm  
passend zu  
Gitterbogen 01-1009B

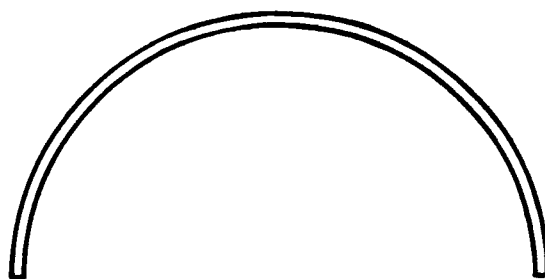

**21B 3001/B2**  
Rohr-Rundbogen  
180 cm, zweiteilig  
passend zu  
Gitterbogen 01-1009C

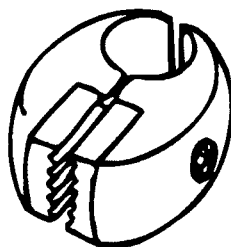

**21 B 3007 a**  
Rohr-Gitterverbinder  
mit 2 Einsätzen  
für die Befestigung  
am Frontrohr

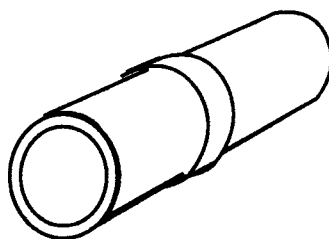

**19-901304**  
für die Verbindung  
Frontrohr-Rohrbogen

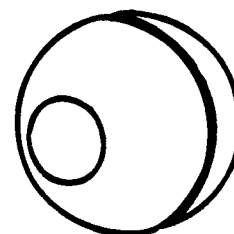

**21 B 3023**  
Abschlusskugel  
für Frontrohr,  
freistehend

## Verbindungen

mit weiteren idétube-Artikeln lassen sich eine Vielfalt von Lösungen realisieren (z.Bsp. Umziehkabine). Verlangen Sie unseren Spezialkatalog.

# Einige Anregungen für mögliche idéflex-Aufstellungen

## Aufstellung an Wand mit Gitterbogen und (Eck-)Tablaren

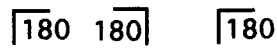

## Aufstellung als Insel mit Gitterbogen, (Viertelkreis-)Tablaren und Kleiderstange

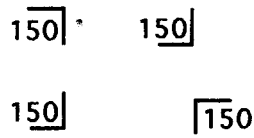
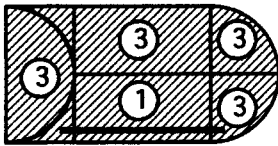

## Aufstellung als niedere Insel in Pyramidenform mit (Eck-)Tablaren

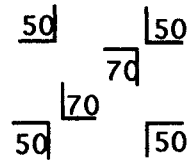
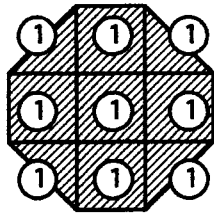

### Legende



Gitterbogen



Grundelement



Tablar



Tablar-Anzahl



Kleiderstange

idéflex 1:50